

SIDES	BOTTOM
Material:0.0396"-Stainless steel 316	

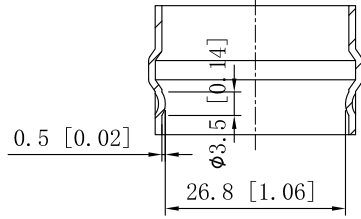

CUTAWAY VIEW C-C

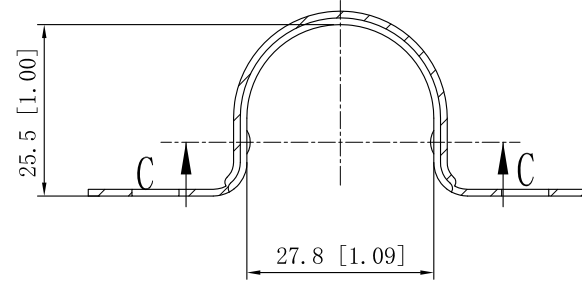

CUTAWAY VIEW A-A

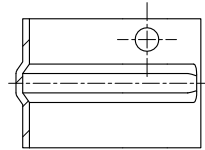

CUTAWAY VIEW B-B

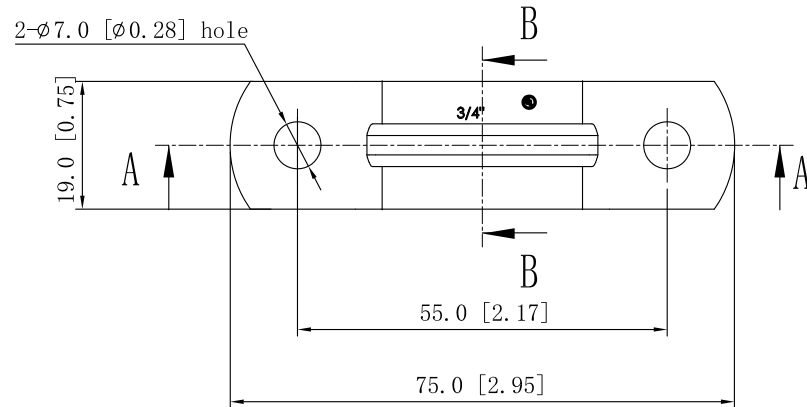

This data sheet is for reference only .SINO AMPLE reserves the right to make changes to the design without prior notice.

DESCRIPTION
TRADE REFERENCE TERMS

STANDARD PACKING	ZHUJI SINO AMPLE METAL PRODUCTS CO., LTD.		
	TITLE TWO-HOLE STRAPS		
	SIZE A4	DWG NO. SATHSSR-75	REV A
	DATA SHEET		