

SIDES

BOTTOM

UL File #

E510054

Material: Steel-(0.061"-0.063")-Galvanized or C.R.S and zinc plated

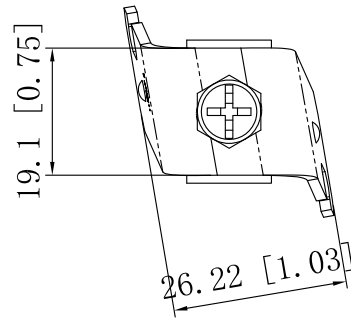

#1/4-20 UNC

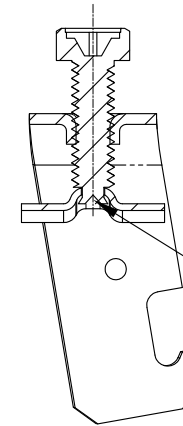
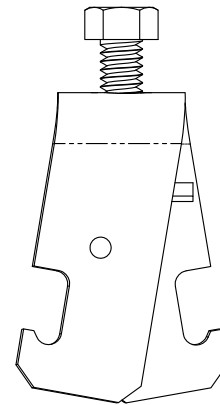
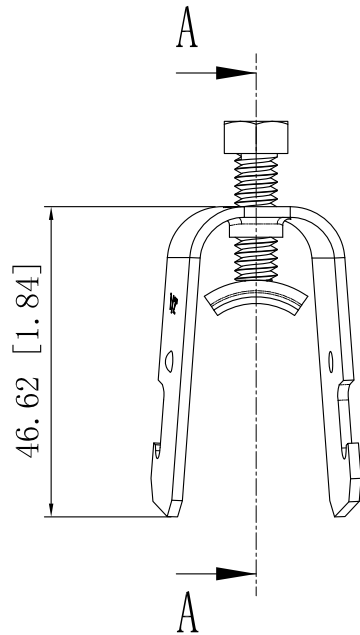
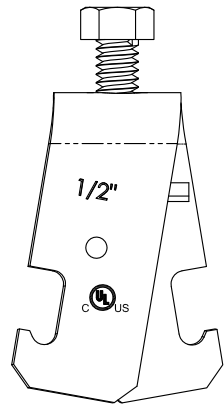
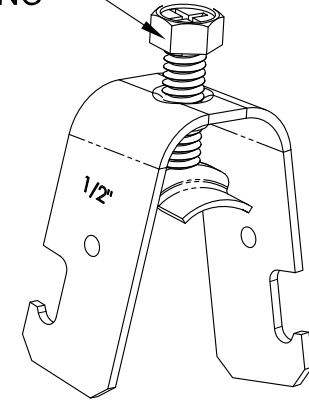

SWEDGE

CUTAWAY VIEW A-A

This data sheet is for reference only .SINO AMPLE reserves the right to make changes to the design without prior notice.

DESCRIPTION

STANDARD PACKING

ZHUJI SINO AMPLE METAL PRODUCTS CO., LTD.

100 PCS

TITLE

ONE-PIECE STRUT CLAMPS

TRADE REFERENCE TERMS

SIZE

A4

DWG NO.

SAOPSC-50

REV

A

DATA SHEET