

SIDES	BOTTOM
2 PCS 8-32×1/2 Screws Installed	
2 PCS 8-32×1/2, 1/8 blank Screws Installed	
Material:Steel-0.0625"-G60 Galvanized	

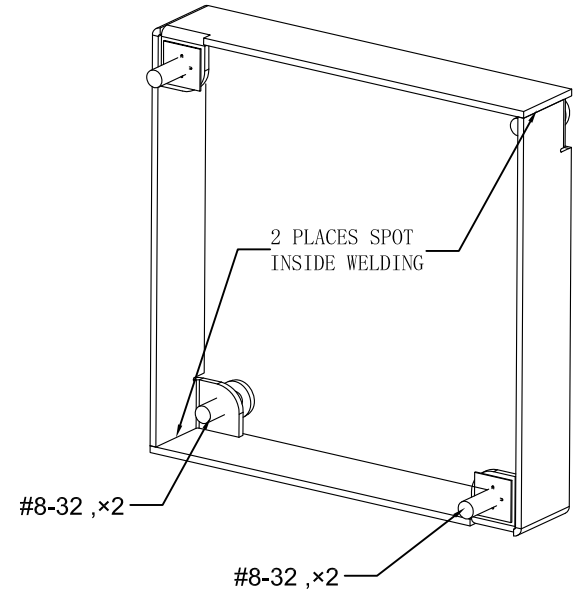

CUTAWAY VIEW A-A

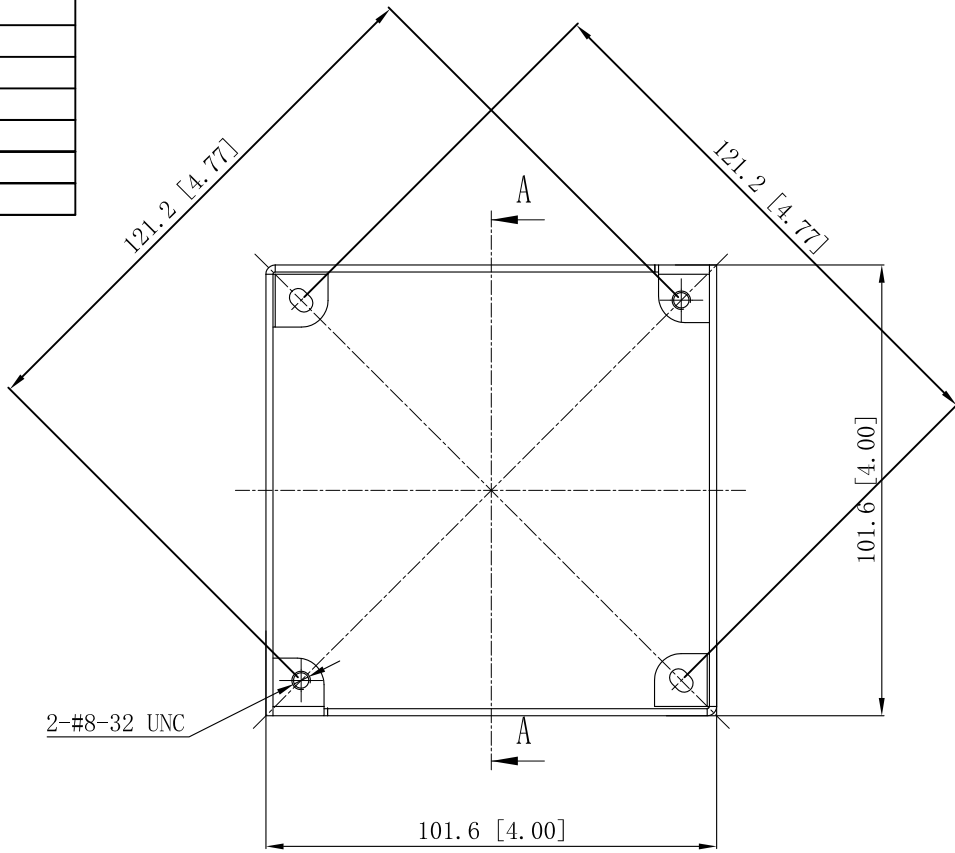
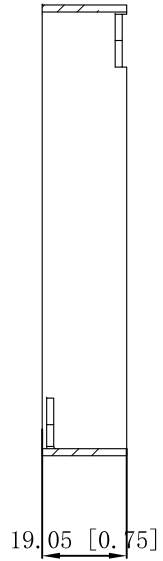

This data sheet is for reference only . SINO AMPLE reserves the right to make changes to the design without prior notice.

DESCRIPTION
TRADE REFERENCE TERMS

STANDARD PACKING	ZHUJI SINO AMPLE METAL PRODUCTS CO. , LTD.		
	TITLE		
SIZE	DWG NO.	SABEX-475	REV
A4			A
DATA SHEET			