

SIDES	BOTTOM
2 Pcs 6-32×5/16 screws Pack In Poly-bag Separately	
2 Pcs 6-32 Nut Pack In Poly-bag Separately	
Material:0.051~0.059"-STAINLESS STEEL 316	

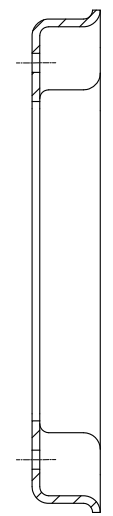

VIEW A

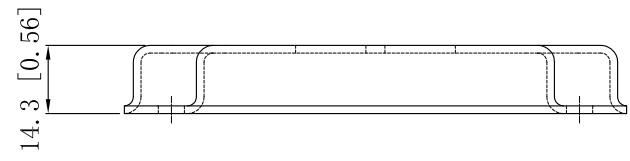
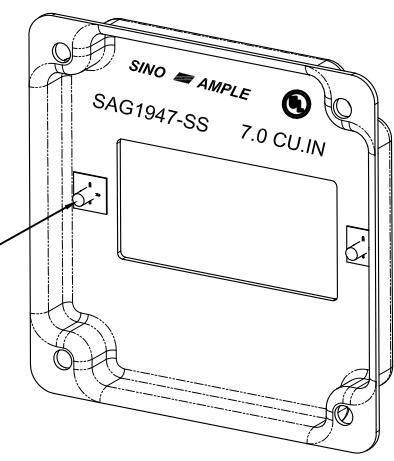
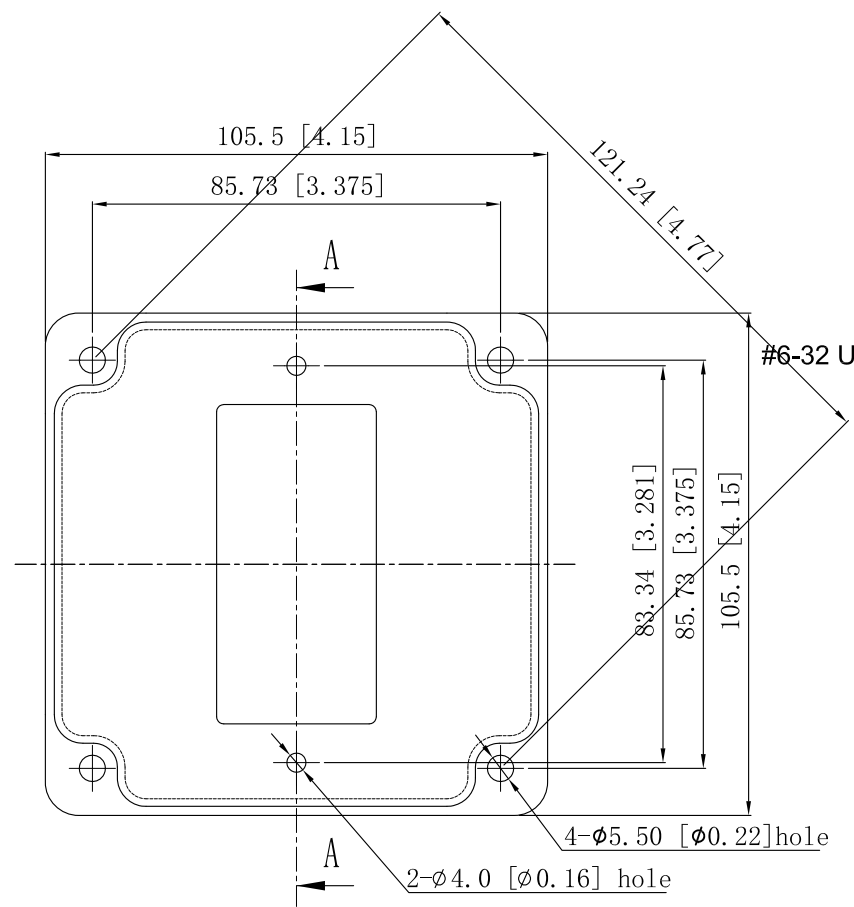

This data sheet is for reference only .SINO AMPLE reserves the right to make changes to the design without prior notice.

DESCRIPTION
TRADE REFERENCE TERMS

STANDARD PACKING	ZHUJI SINO AMPLE METAL PRODUCTS CO., LTD.		
50 PCS	TITLE 4" SQUARE INDUSTRIAL "GARVIN" COVERS		
	SIZE A4	DWG NO. SAG1947-SS	REV A
	DATA SHEET		