

UL File # E508835

SIDES	BOTTOM
Material: Steel-0.0625"-G60 Galvanized	

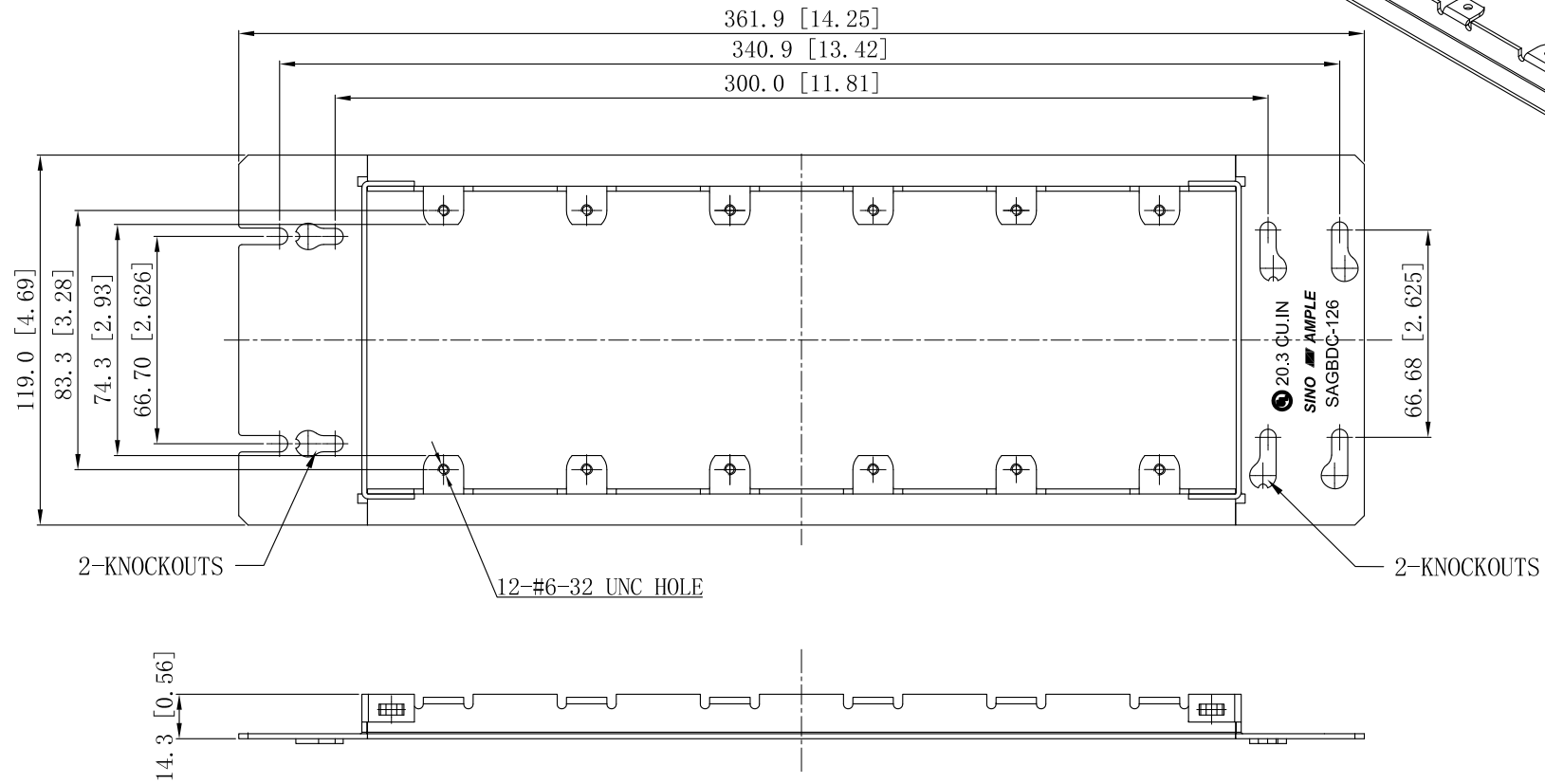
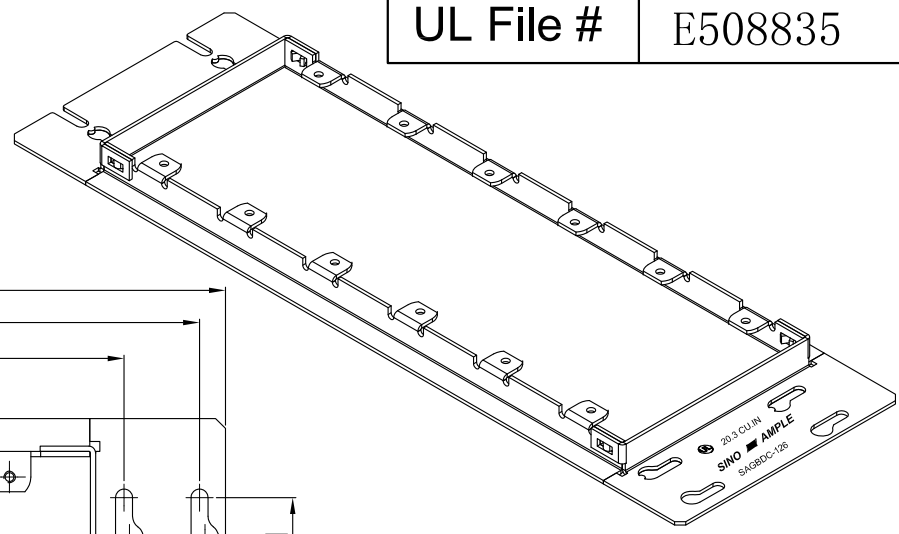

This data sheet is for reference only .SINO AMPLE reserves the right to make changes to the design without prior notice.

DESCRIPTION
TRADE REFERENCE TERMS

STANDARD PACKING	ZHUJI SINO AMPLE METAL PRODUCTS CO., LTD.		
5 PCS	TITLE 1/2"RAISED MULTI-GANG DEVICE COVERS		
	SIZE A4	DWG NO. SAGBDC-126	REV A
	DATA SHEET		