

UL File # E508835

SIDES	BOTTOM
Material: Steel-0.0625"-G60 Galvanized	

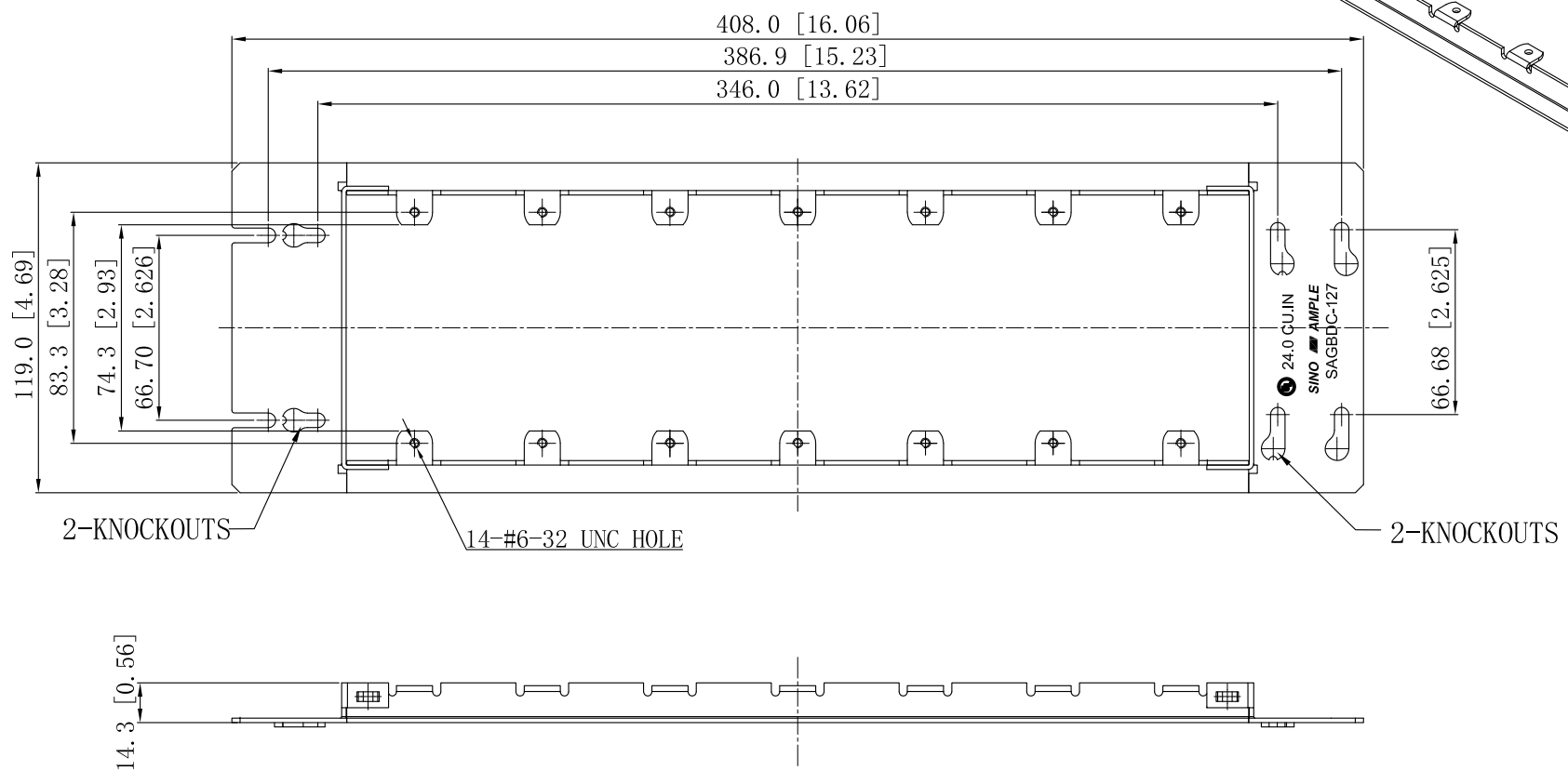
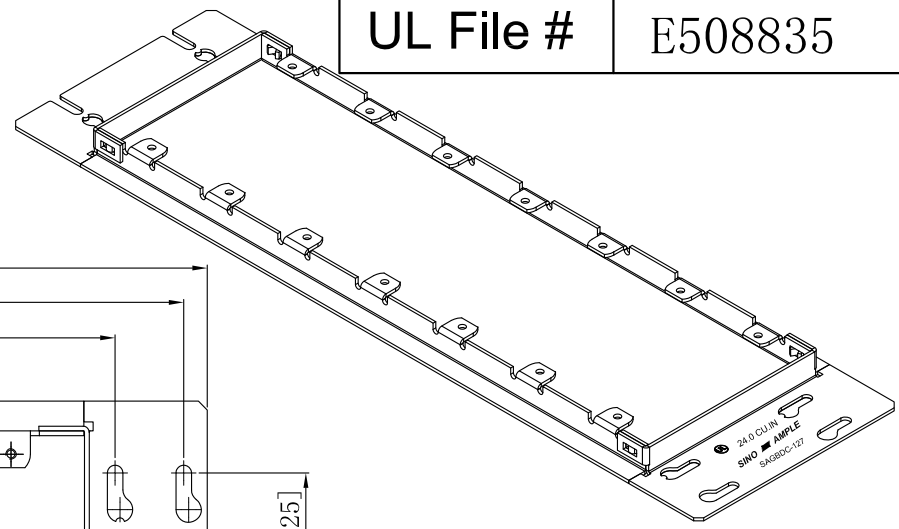

This data sheet is for reference only . SINO AMPLE reserves the right to make changes to the design without prior notice.

DESCRIPTION
TRADE REFERENCE TERMS

STANDARD PACKING	ZHUJI SINO AMPLE METAL PRODUCTS CO., LTD.		
5 PCS	TITLE 1/2"RAISED MULTI-GANG DEVICE COVERS		
	SIZE A4	DWG NO. SAGBDC-127	REV A
	DATA SHEET		