

SIDES

BOTTOM

UL File #

E508835

Material: Steel-0.0625"-G60 Galvanized

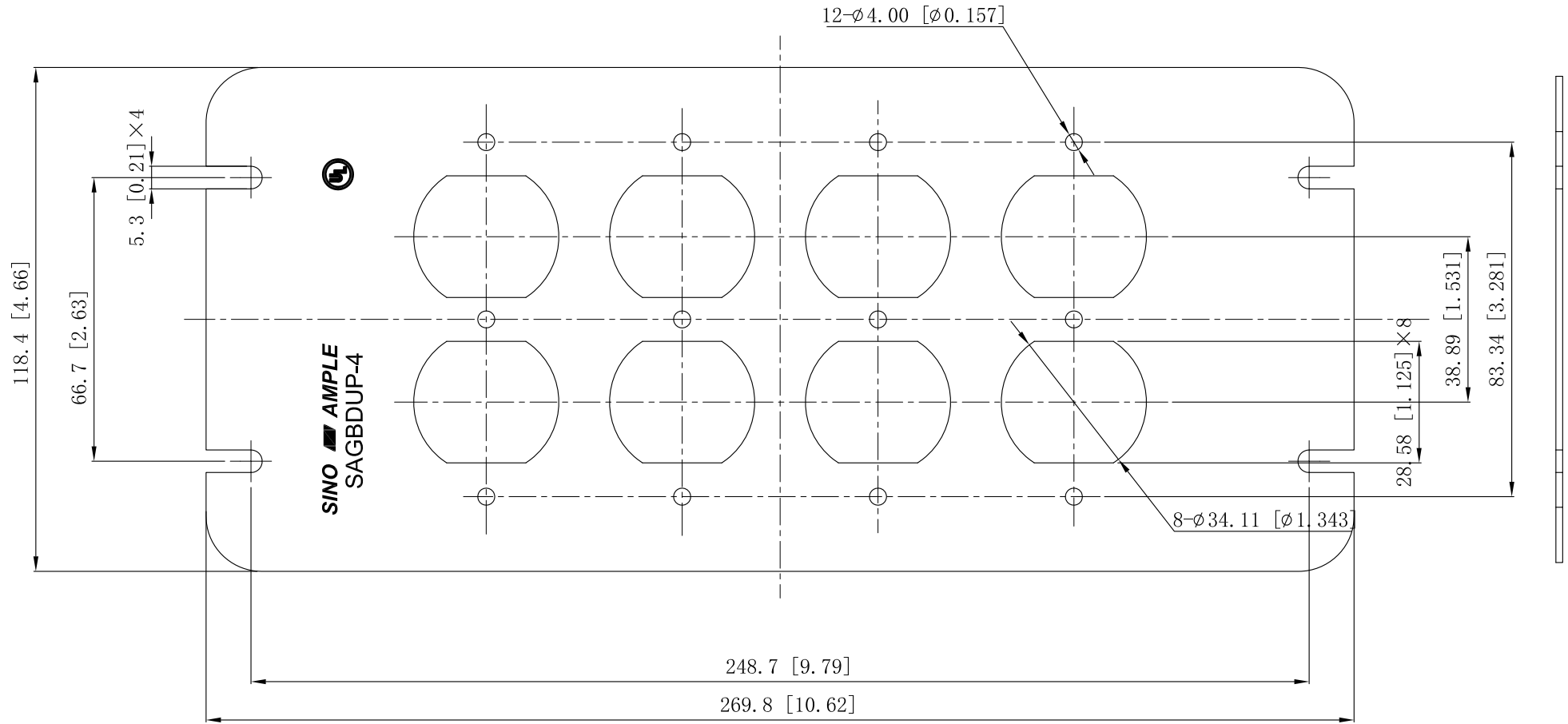

DESCRIPTION

This data sheet is for reference only .SINO AMPLE reserves the right to make changes to the design without prior notice.

TRADE REFERENCE TERMS

STANDARD PACKING

ZHUJI SINO AMPLE METAL PRODUCTS CO., LTD.

5 PCS

TITLE

FLAT DUPLEX MULTI-GANG BOX COVER

SIZE
A4

DWG NO.

SAGBDUP-4

REV
A

DATA SHEET