

SIDES

BOTTOM

UL File #

E508835

Material:Steel-0.0625"-G60 Galvanized

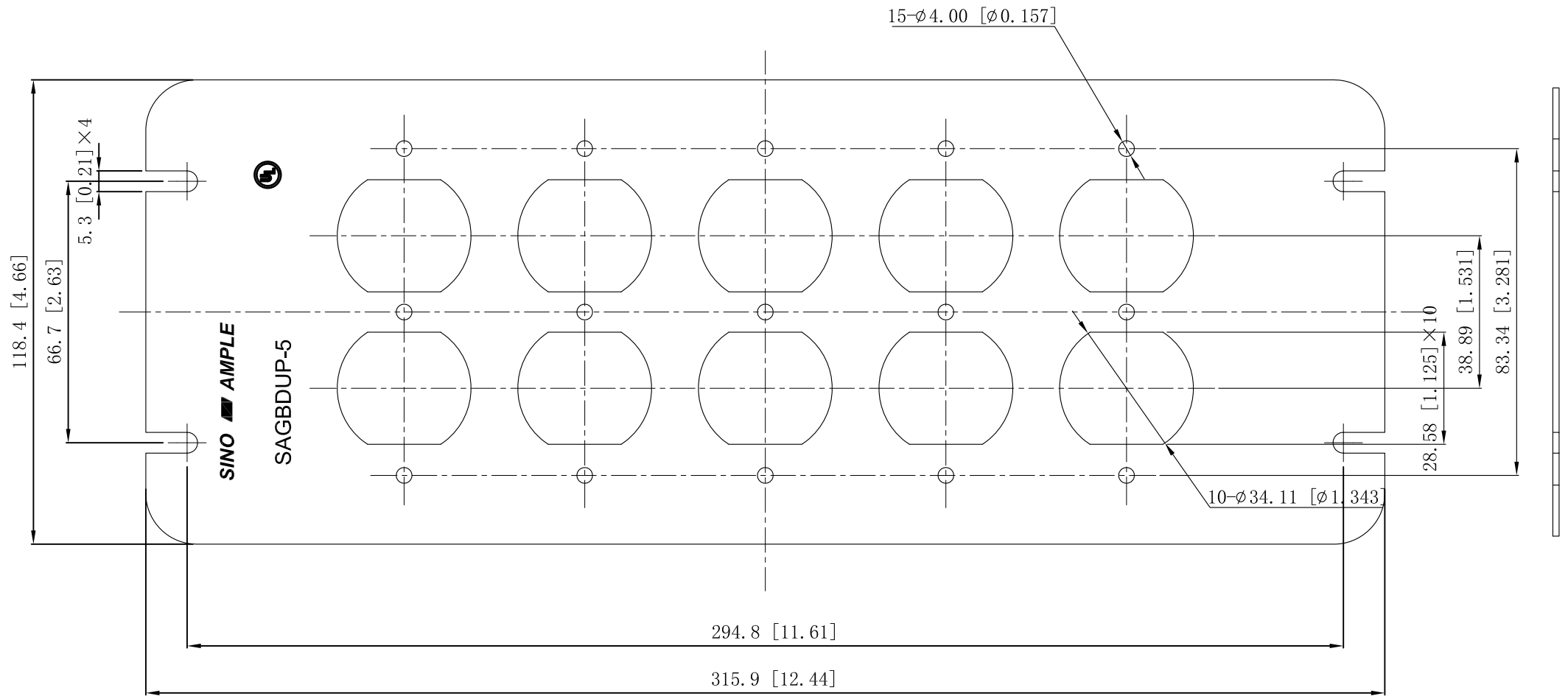

This data sheet is for reference only .SINO AMPLE reserves the right to make changes to the design without prior notice.

DESCRIPTION
TRADE REFERENCE TERMS

STANDARD PACKING	ZHUJI SINO AMPLE METAL PRODUCTS CO. , LTD.		
1 PCS	TITLE FLAT DUPLEX MULTI-GANG BOX COVER		
	SIZE A4	DWG NO. SAGBDUP-5	REV A
	DATA SHEET		