

SIDES	BOTTOM
20 1/2"-3/4" MOON KNOCKOUTS	
Material: Steel-0.0625"-G60 Galvanized	

16 1/2"-3/4" MOON KNOCKOUTS $\phi=22.50$ [$\phi=0.886$]
 $\phi=28.50$ [$\phi=1.122$] MIRROR

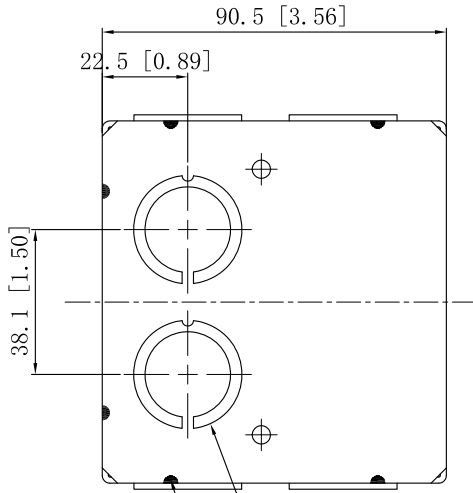
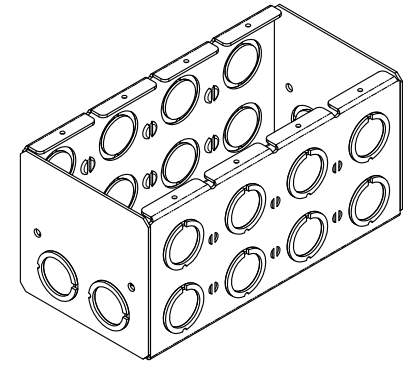
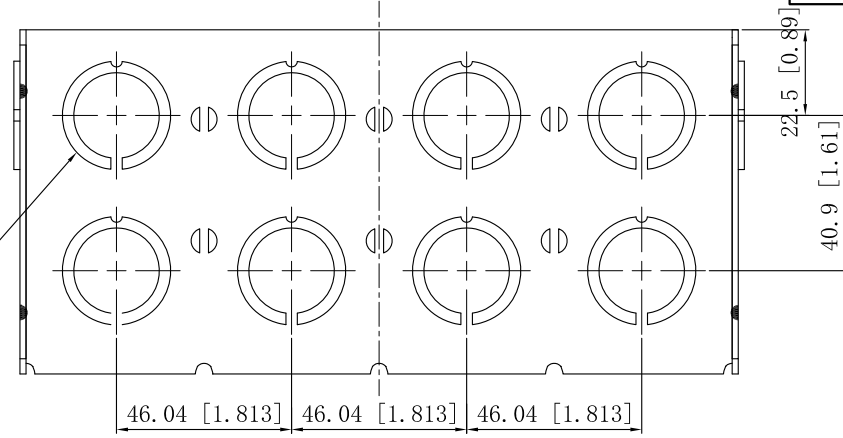

4 1/2"-3/4" MOON KNOCKOUTS $\phi=22.50$ [$\phi=0.886$]
 $\phi=28.50$ [$\phi=1.122$] MIRROR

12 PLACES SPOT WELDING

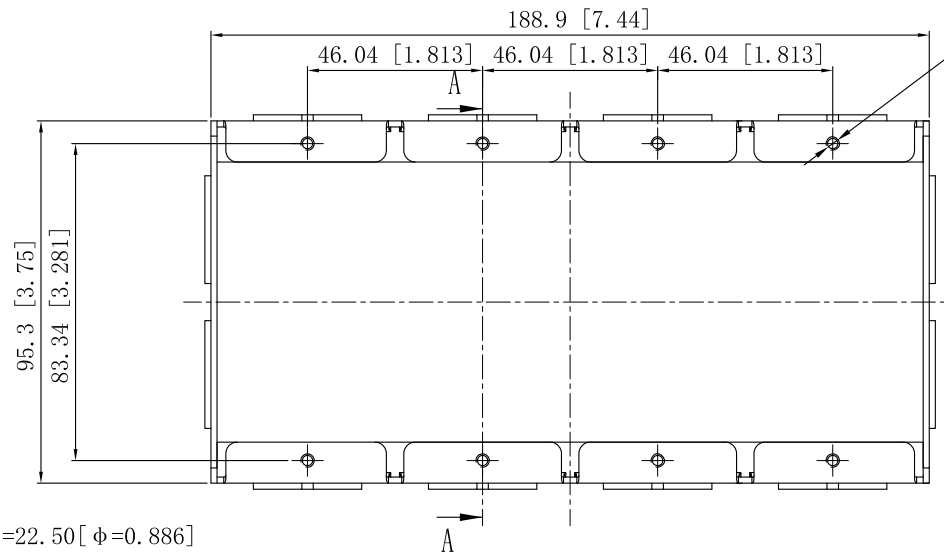

8-#6-32 UNC HOLE

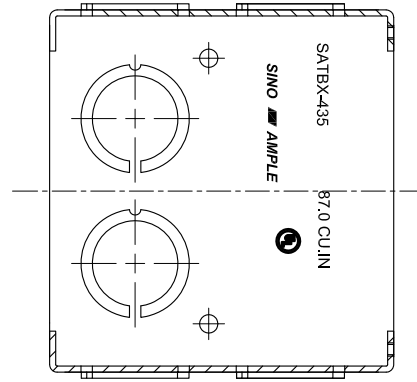

CUTAWAY VIEW A-A

This data sheet is for reference only . SINO AMPLE reserves the right to make changes to the design without prior notice.

DESCRIPTION
TRADE REFERENCE TERMS

STANDARD PACKING	ZHUJI SINO AMPLE METAL PRODUCTS CO., LTD.		
5 PCS	TITLE SOLID MASONRY BOX 3-1/2" DEEP		
	SIZE A4	DWG NO. SATBX-435	REV A
	DATA SHEET		